

9 October 2007



Scientific Background on the Nobel Prize in Physics 2007

The Discovery of Giant Magnetoresistance

compiled by the Class for Physics of the Royal Swedish Academy of Sciences

1. Introduction

The phenomenon called **magnetoresistance** (MR) is the change of resistance of a conductor when it is placed in an external magnetic field. For ferromagnets like iron, cobalt and nickel this property will also depend on the direction of the external field relative to the direction of the current through the magnet. Exactly 150 years ago W. Thomson (1) (Lord Kelvin) measured the behaviour of the resistance of iron and nickel in the presence of a magnetic field. He wrote “*I found that iron, when subjected to a magnetic force, acquires an increase of resistance to the conduction of electricity along, and a diminution of resistance to the conduction of electricity across, the lines of magnetization*”. This difference in resistance between the parallel and perpendicular case is called **anisotropic magnetoresistance** (AMR) (2). It is now known that this property originates from the electron spin-orbit coupling. In general magnetoresistance effects are very small, at most of the order of a few per cent.

The MR effect has been of substantial importance technologically, especially in connection with read-out heads for magnetic disks and as sensors of magnetic fields. The most useful material has been an alloy between iron and nickel, $\text{Fe}_{20}\text{Ni}_{80}$ (permalloy). In general, however, there was hardly any improvement of the performance of magnetoresistive materials since the work of Kelvin. The general consensus in the 1980s was that it was not possible to significantly improve on the performance of magnetic sensors based on magnetoresistance.

Therefore it was a great surprise when in 1988 two research groups independently discovered materials showing a very large magnetoresistance, now known as **giant magnetoresistance** (GMR). These materials are so called magnetic multilayers, where layers of ferromagnetic and non-magnetic metals are stacked on each other (figure 1). The widths of the individual layers are of nanometre size – i.e. only a few atomic layers thick. In the original experiments leading to the discovery of GMR one group, led by Peter Grünberg (3), used a trilayer system $\text{Fe}/\text{Cr}/\text{Fe}$, while the other group, led by Albert Fert (4), used multilayers of the form $(\text{Fe}/\text{Cr})_n$ where n could be as high as 60.

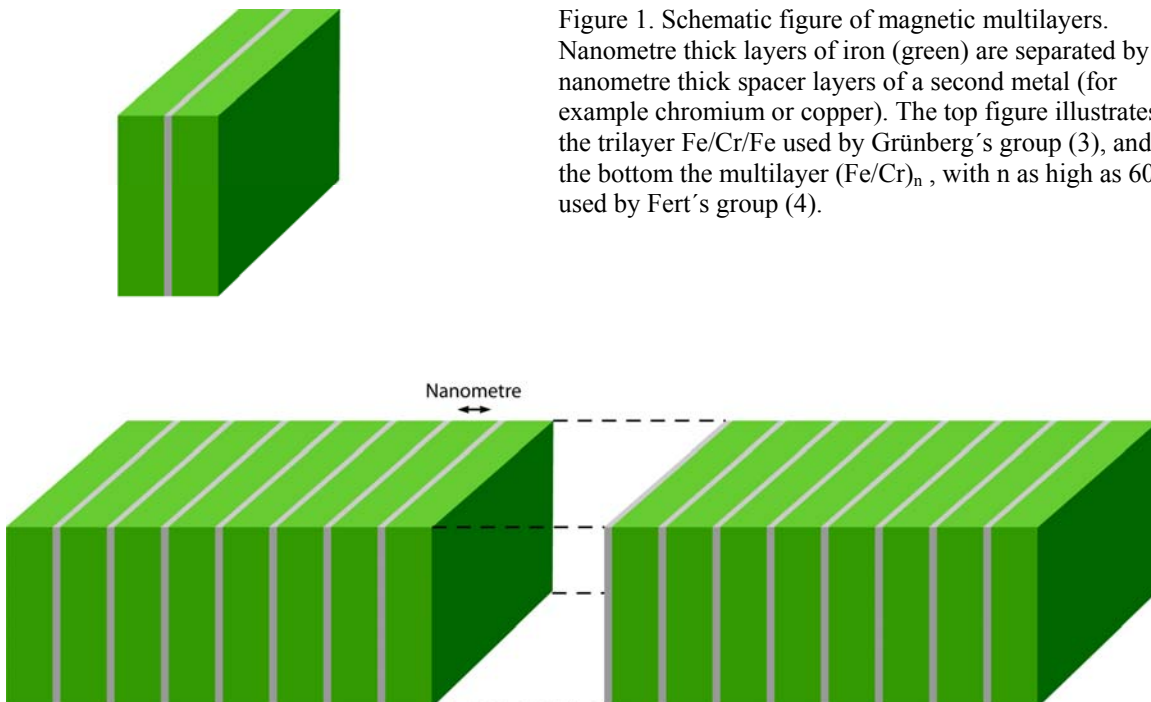

Figure 1. Schematic figure of magnetic multilayers. Nanometre thick layers of iron (green) are separated by nanometre thick spacer layers of a second metal (for example chromium or copper). The top figure illustrates the trilayer $\text{Fe}/\text{Cr}/\text{Fe}$ used by Grünberg’s group (3), and the bottom the multilayer $(\text{Fe}/\text{Cr})_n$, with n as high as 60, used by Fert’s group (4).

In figure 2 the measurements of Grünberg's group are displayed (left) together with those of Fert's group (right). The y-axis and x-axis represent the resistance change and external magnetic field, respectively. The experiments show a most significant negative magnetoresistance for the trilayer as well as the multilayers. The systems to the right, involving large stacks of layers, show a decrease of resistance by almost 50% when subjected to a magnetic field. The effect is much smaller for the system to the left, not only because the system is merely a trilayer but also because the experiments led by Grünberg were made at room temperature, while the experiments reported by Fert and co-workers were performed at very low temperature (4.2K).

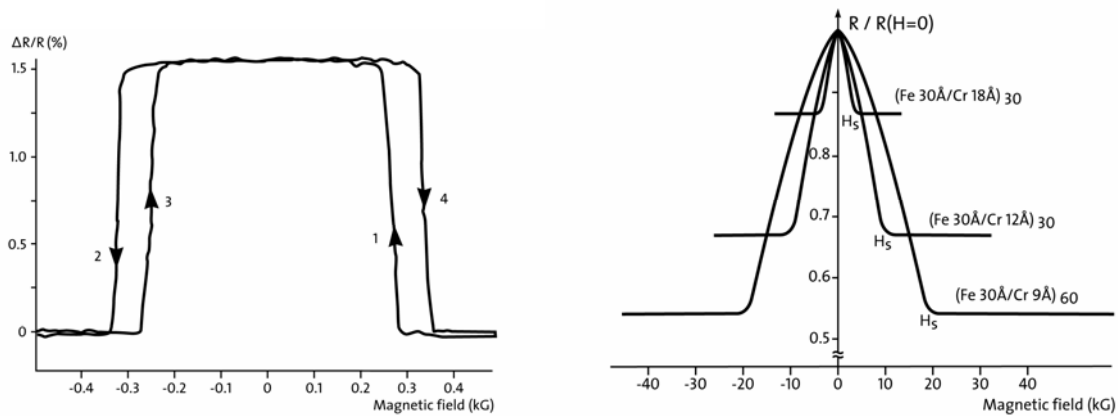

Figure 2. After refs. (3) and (4).

Left: Magnetoresistance measurements (3) (room temperature) for the trilayer system Fe/Cr/Fe. To the far right as well as to the far left the magnetizations of the two iron layers are both parallel to the external magnetic field. In the intermediate region the magnetizations of the two iron layers are antiparallel. The experiments also show a hysteresis behaviour (difference 1 and 4 (2 and 3)) typical for magnetization measurements.

Right: Magnetoresistance measurements (4) (4.2K) for the multilayer system $(\text{Fe/Cr})_n$. To the far right ($>H_S$, where H_S is the saturation field) as well as to the far left ($< -H_S$) the magnetizations of all iron layers are parallel to the external magnetic field. In the low field region every second iron layer is magnetized antiparallel to the external magnetic field. 10 kG = 1 Tesla.

Grünberg (3) also reported low temperature magnetoresistance measurements for a system with three iron layers separated by two chromium layers and found a resistance decrease of 10%.

Not only did Fert and Grünberg measure strongly enhanced magnetoresistivities, but they also identified these observations as a new phenomenon, where the origin of the magnetoresistance was of a totally new type. The title of the original paper from Fert's group already referred to the observed effect as "Giant Magnetoresistance". Grünberg also realized at once the new possibilities for technical applications and patented the discovery. From this very moment the area of thin film magnetism research completely changed direction into magnetoelectronics.

The discovery of giant magnetoresistance immediately opened the door to a wealth of new scientific and technological possibilities, including a tremendous influence on the technique of data storage and magnetic sensors. Thousands of scientists all around the world are today working on magnetoelectronic phenomena and their exploration. The story of the GMR effect is a very good demonstration of how a totally unexpected scientific discovery can give rise to completely new technologies and commercial products.

2. Background

A. Ferromagnetic metals

Among the d transition metals (Sc...Cu, Y...Ag, Lu...Au, i.e. 3d, 4d, and 5d transition elements), the 3d metals iron, cobalt and nickel are well-known to be ferromagnets. Among the lanthanides (the 4f elements, La-Lu) gadolinium is also a ferromagnet. The origin of magnetism in these metals lies in the behaviour of the 3d and 4f electrons, respectively. In the following it is mainly the magnetism in the 3d elements that will be discussed.

In the free atoms, the 3d and 4s atomic energy levels of the 3d transition elements are hosts for the valence electrons. In the metallic state these 3d and 4s levels are broadened into energy bands. Since the 4s orbitals are rather extended in space there will be a considerable overlap between 4s orbitals belonging to neighbouring atoms, and therefore the corresponding 4s band is spread out over a wide energy range (15–20 eV). In contrast to this, the 3d orbitals are much less extended in space. Therefore the energy width of the associated 3d energy band is comparatively narrow (4–7 eV). In practice one cannot make a clear distinction between the 3d and 4s orbitals since they will hybridize strongly with each other in the solid. Nevertheless for simplicity this two band picture will be used here and the 3d electrons will be considered as metallic – i.e. they are itinerant electrons and can carry current through the system, although they are still much less mobile than the 4s electrons.

A useful concept in the theory of solids is the electron density of states (DOS), $n(E)$, which represents the number of electrons in the system having energy within the interval $(E, E+dE)$. According to the exclusion principle for fermions (in this case electrons), only one electron can occupy a particular state. However each state is degenerate with respect to spin and can therefore host both an electron with spin up and an electron with spin down. In the ground state all the lowest energy levels are filled by electrons and the highest occupied energy level is called the Fermi energy, E_F . In figure 3 (left) the density of states is illustrated schematically for a non-magnetic 3d metal, sometimes referred to as a paramagnet, where there are equally many electrons with spin up as with spin down, i.e. there is no net magnetization. The so called spin polarization, P , [$P = (N_{\uparrow} - N_{\downarrow}) / (N_{\uparrow} + N_{\downarrow})$, where N_{\uparrow} (N_{\downarrow}) = number of electrons with spin up (down)], is here equal to zero.

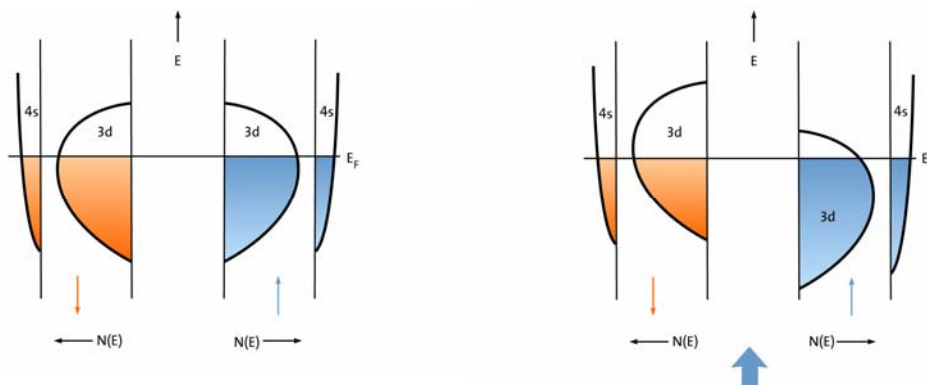

Figure 3. **To the left** a schematic plot is shown for the energy band structure of a d transition metal. The density of states $N(E)$ is shown separately for the spin up and down electrons and where a simplified separation has been made between the 4s and 3d band energies. For the non-magnetic state these are identical for the two spins. All energy levels below the Fermi energy are occupied states (orange and blue). The coloured area (orange + blue) corresponds to the total number of valence electrons in the metal. **To the right** the corresponding picture is illustrated for a ferromagnetic state, with a spin-polarization chosen to be in the up direction ($N_{\uparrow} > N_{\downarrow}$; blue area > orange area). This polarization is indicated by the thick blue arrow at the bottom figure to the right.

For a ferromagnet N_{\uparrow} is larger than N_{\downarrow} , so that there is a net spin polarization, $P > 0$. In order to compare the energy for the ferromagnetic state with the energy for the paramagnetic state one can start from the paramagnetic state and allow for a small imbalance in the number of spin up and spin down electrons. A transfer of spin down electrons from the spin down band into the spin up band leads to more exchange energy in the system, which means a **lowering** of the total energy (a gain) On the other hand such a process requires a transfer of electrons from spin down levels below the initial Fermi energy, into spin up levels situated just above the initial Fermi energy. This will necessarily lead to a loss of band energy, “kinetic energy” and thus to an **increase** of the total energy (a loss). Thus there is a competition between two opposite effects. This can be formulated as the so called Stoner criterion (5) for magnetism, namely that when

$$I N(E_F) > 1,$$

the system will be a ferromagnet. Here I is called the Stoner exchange parameter and $N(E_F)$ is the density of states at the Fermi energy. The Stoner parameter has a specific value for the individual element, while $N(E_F)$ depends much more on the particular spatial arrangements of the atoms relative to each other (like crystal structure). Furthermore, and most important, $N(E_F)$ tends to be high for systems with narrow energy bands as is the case for the heavier 3d transition elements (Fe, Co and Ni). This is the explanation for the ferromagnetism among the d transition metals.

The situation for a ferromagnetic spin polarization is illustrated to the right in figure 3 (with a direction chosen to be upwards). The vertical displacement between the spin up and spin down densities of states exemplifies the exchange energy splitting between the spin up and spin down energy bands, which is relevant for the metals Fe, Co and Ni. In particular the density of states at the Fermi energy $N(E_F)$ can now be very different for the two spin bands. This also means that for a ferromagnet the character of the state at the Fermi energy is quite different for spin up and spin down electrons. This is an important observation in connection with the GMR effect. This picture of 3d energy bands (figure 3 to the right) for the ferromagnetic metals is often referred to as the itinerant model (6), also known as the Stoner-Wohlfarth model (5).

One important property of ferromagnets is that at high temperature their magnetism is lost. This happens at a well defined temperature, the so called Curie temperature, T_C . For the present systems (Fe, Co and Ni) these critical temperatures are far above room temperature and can be neglected.

B. Resistance

An electrical current of electrons sent through a metallic system will always experience a resistance R . (Exceptions are the so called superconductors where below a certain temperature the current can flow without resistance). There are a number of reasons for this. In a crystal the atoms will always vibrate (phonons) around their equilibrium positions, thereby deviating from the perfect lattice positions, and the conduction electrons may be scattered by these deviations (electron – phonon interaction). Other important contributions to the resistance of a metal are scattering of electrons against impurities and defects. The only electrons that participate in the electrical conduction process are those at (or very close to) the Fermi level. For paramagnetic metals there is no difference between the spin up and spin down electrons, and they contribute equally to the resistance.

Already in 1936 Sir Nevil Mott (7) considered the electrical conductivity of d transition elements. He suggested that the conductivity was mainly determined by the 4s electrons which are easily mobile due to the wide energy range of the bands derived from the 4s-states. However in a scattering process the s electrons can scatter into the many d states which are available at the Fermi level. Therefore they

experience a strong scattering giving rise to a considerable resistance. On the other hand for Cu, the element following Ni in the Periodic Table, all the 3d states are situated below the Fermi level and therefore not available for scattering processes. This explains the particularly high conductivity of Cu.

In the 1960s and 1970s Fert together with Campbell studied in great detail the conductivity of 3d ferromagnetic materials (3,8). They carried out extensive investigations of resistivity changes which occur when low concentrations of alloying elements, like Cr and other transition metals, are put as scattering centres into for example Fe and Ni. From these studies they could confirm that in a ferromagnet like iron there are two types of carriers, one made up from spin up electrons and one from spin down electrons. Since the density of states at the Fermi surface is quite different for the two spin states it follows that there is a significant difference in resistance for the spin up electrons and the spin down electrons. There could also be contributions to the resistance from scattering processes where the spins are flipped. This could for example be due to scattering against spin waves or from the spin orbit coupling. However these effects are small and will be neglected here. Thus the picture which is emerging is that the electrical current in a ferromagnet like iron, cobalt and nickel consists of spin up and spin down carriers, which experience rather different resistances.

C. Growth of superlattices

From the beginning of the 1970s the development in physics, chemistry and materials science had led to new experimental techniques allowing scientists to manufacture completely novel materials. Using what was called epitaxial growth one could start to produce artificial materials building one atomic layer after the next. Techniques that were introduced at this time involved for example sputtering, laser ablation, molecular beam epitaxy and chemical vapour deposition. Molecular beam epitaxy was already being used in the late 1960s to make thin semiconducting materials and at the end of the 1970s nanometre thick metallic layers could be produced. This was first applied to non-magnetic metals, but later also to metallic ferromagnets. At the same time, a number of characterization techniques had been largely improved, utilizing for example the magneto-optic Kerr effect (MOKE) and light scattering from spin waves. Using these methods it was possible to grow metallic multilayers involving for example iron and study their magnetic properties.

In order to produce well-defined materials the choice of substrate on which to grow the material is of great importance. Commonly used materials are silicon, silicon dioxide, magnesium oxide and aluminium oxide. To obtain well-behaved metallic multilayers it is important that the lattice parameters for the different metallic layers match each other (figure 4) and it is also an advantage if the two metals forming the multilayer have the same crystal structure. This is the case for chromium and iron, where both metals adapt the bcc (body-centred cubic) crystal structure and where in addition they have very similar lattice spacings. This was important for the studies for which this Nobel Prize is awarded undertaken by the groups of Fert and Grünberg. In addition it was also extremely important that it was now possible to grow multilayers where the spatial separation between the magnetic layers is of the order of nanometres. In order to exhibit the GMR effect the mean free path length for the conduction electrons has to greatly exceed the interlayer separations so that the electrons can travel through magnetic layers and pick up the GMR effect. Without the new experimental growth techniques this requirement could not have been fulfilled and the GMR effect would have remained unknown. In this connection it should be mentioned that, in several publications prior to the work of Fert and Grünberg, there were reports of observations of substantial (of the order of a few per cent) magnetoresistance effects (9,10,11,12). In none of them were the observations recognized as a new effect.

D. Interlayer coupling

It has been known for a long time that disturbances like defects and impurities in metallic systems become screened by the surrounding conduction electrons. The disturbance gives rise to decaying oscillations of the electron density as a function of the distance from the disruption (so called Friedel oscillations). Similarly, a magnetic impurity atom in a metallic surrounding gives rise to an induced spin polarization of the electron density. With increasing distance from the magnetic impurity there will be an oscillation in the sign of the polarization and the disturbance will also decay in magnitude with distance. As a consequence, the magnetic moment of a second impurity placed relatively close to the first one, will become aligned parallel or antiparallel to the magnetic moment of the first moment depending on the sign of the induced polarization at that particular distance. This coupling (exchange coupling) between magnetic moments (schematically shown in figure 5) was well-known for the rare-earth metals where each atom possesses a magnetic moment originating from the very tightly bound (and localized) 4f electronic configuration positioned deep inside the atom. In fact the magnetism of the heavier lanthanide metals originate from this interaction.

As already mentioned gadolinium is a ferromagnet where the magnetic moments originate from the localized 4f electrons on each atom having a $4f^7$ configuration. That is, all the 4f magnetic moments point in the same direction and surrounding these moments there are three conduction electrons per atom which mediate the interaction between the 4f magnetic moments. In 1986 Majkrzak et al. (13) published work on a superlattice of Gd/Y/Gd where they reported an antiparallel magnetic moment alignment between the Gd layers for the case of 10 monolayers of Y. This could be understood from the way that a ferromagnetic Gd layer induces an oscillatory spin polarization of the normally non-magnetic Y metal and that the second Gd layer happens to be at a distance where an antiferromagnetic alignment is preferred. Practically simultaneously Grünberg et al. (14) discovered an antiferromagnetic coupling between the iron layers for the Fe/Cr/Fe trilayer. This can be explained in a similar way to the Gd/Y/Gd case. It should be remarked, however, that in both cases, due to the geometry, there are important contributions to the interlayer exchange coupling from quantum interference of the electron waves reflected at the magnetic layers (15). In the present context it is however sufficient to conclude that the important role of the electrons of the non-magnetic layer(s) is that they provide the coupling mechanism between the magnetic layers.

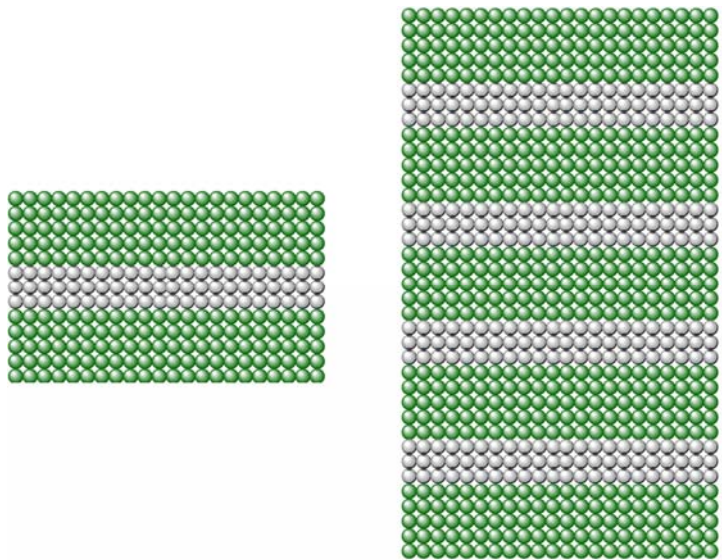

Figure 4. Illustration of superlattices. This is essentially the same figure as in figure 1, but now with atomic resolution. From this it becomes obvious that the lattice mismatch between the two materials needs to be small in order to be able to grow multilayers with well behaved interfaces.

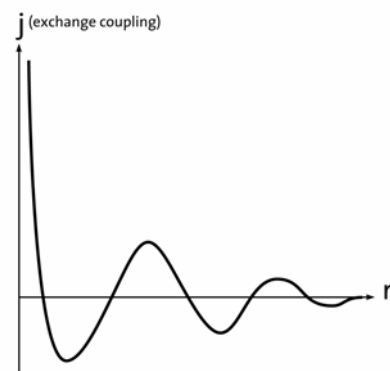

Figure 5. Schematic illustration of the behaviour of the exchange coupling as a function of distance.

The next step was to investigate the dependence of the coupling on the thickness of the intermediate non-magnetic layers. Several groups identified a change of sign with increasing thickness (13,15,16,17,18). A thorough study of the dependence of the oscillatory behaviour on the thickness of the non-magnetic layer, its dependence on the material of the non-magnetic layer as well as on the dependence of the material of the magnetic layer itself was made by Parkin (1). Here he actually utilized the GMR effect as a tool to study this dependence. In the preparation of the multilayers Parkin used a magnetron sputter deposition technique. With this method it was possible to prepare a large number of samples under comparable conditions. This extensive work was important for the further development of the GMR effect into a working device (20,21,22).

3. Giant Magnetoresistance

The resistance of a GMR device can be understood from the following somewhat simplified picture. In figure 6 a plot of the magnetic configuration for the FM/NM/FM (ferromagnetic/non-magnetic/ferromagnetic) multilayer is made together with the corresponding electron density of state for the two ferromagnetic sides (FM). In the absence of a magnetic field (at the top) the two FM layers are separated from each other in such a way that they have opposite magnetization directions. In the presence of a magnetic field the magnetizations of the two FM layers will be parallel (at the bottom). An electrical current is now sent through the system for both configurations. As already mentioned above the current through the FM layer is composed of two types – one spin up current and one spin down current – and the resistance for these two currents will differ. When an electron leaves the first iron layer and enters the non-magnetic metal there will be additional scattering processes giving rise to extra resistance. Since the spin up and spin down particles have different density of states at the Fermi level (or rather, they originate from energy levels having different character), the resistance not only within the FM layers, but also that originating from the FM/NM interface will be different for the two spins. Inside the NM layer the up and down spins will experience the same resistance, but generally this is low compared to those in the FM layers and FM/NM interfaces and can here be neglected.

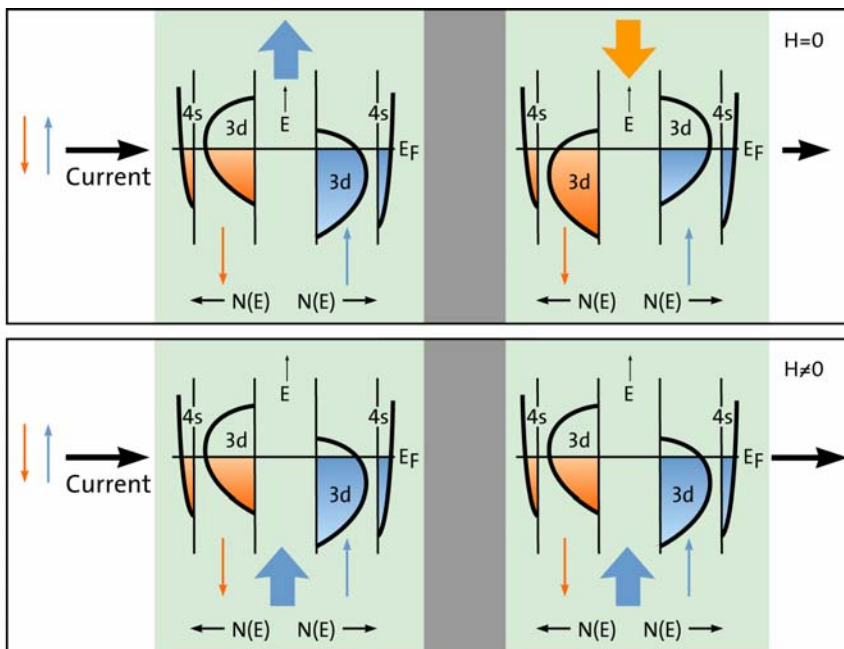

Figure 6. Schematic illustration of the electronic structure of a trilayer system with two ferromagnetic layers (light green) on both sides separated by nonmagnetic material (grey). The top figure is for the case without external magnetic field ($H=0$), i.e. when the two magnetic layers have opposite magnetizations (indicated by the thick blue and orange arrows at the top of the topmost figure). The bottom figure is for the case when an external magnetic field ($H \neq 0$) has forced the two magnetizations to be parallel (two thick blue arrows at the bottom of the lower figure.). The magnitude of the four magnetizations is the same.

When the electrons enter the second iron layer they will again experience spin dependent scattering at the NM/FM interface. Finally the spin up and spin down electrons go through the second iron layer with the same resistance as in the first iron layer, which still of course differs for the two spins. For simplicity the resistance for the spin up (down) electrons through the FM layer and the scattering at the interface to the NM layer will be called R_{\uparrow} (R_{\downarrow}). Thus when the two layers have parallel spin polarizations (magnetizations), i.e. in the presence of an external magnetic field (H), the resistance for the spin up channel is $2 R_{\uparrow}$ and for the spin down channel it is $2 R_{\downarrow}$. Standard addition of resistances for a parallel current configuration gives the following total resistance, R_H , in the presence of an external magnetic field; $R_H = 2R_{\uparrow}R_{\downarrow}/(R_{\uparrow} + R_{\downarrow})$.

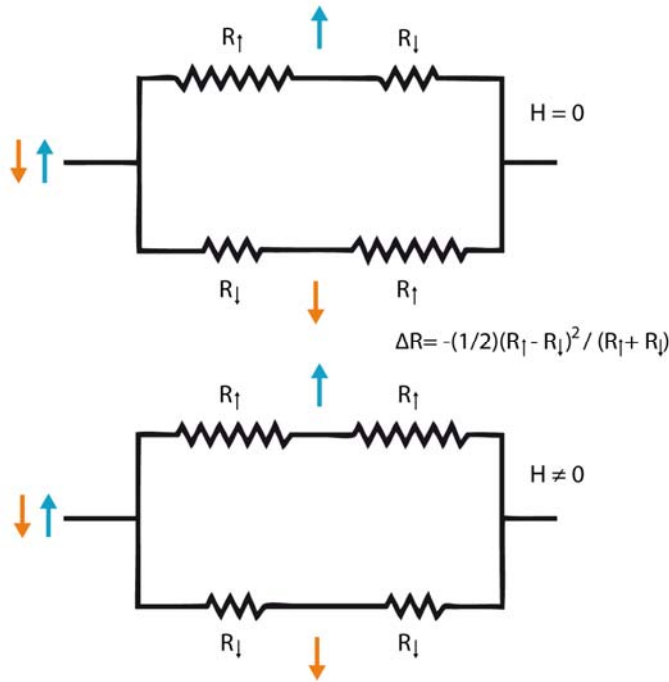

Figure 7. The same physical system as in figure 6. The magnetic layers are now represented by resistances R_{\uparrow} and R_{\downarrow} . This shows very clearly that the total resistance for the two cases are different, i.e. there is a magnetoresistance effect. In case $R_{\uparrow} \gg R_{\downarrow}$ it is practically only the lowest of the four possibilities which will permit a current. In the lower picture with parallel magnetizations the resistance for the spin up (spin down) electrons will be R_{\uparrow} (R_{\downarrow}) in both magnetic layers. In the upper picture with antiparallel magnetizations the spin up (spin down) electrons will have a resistance R_{\uparrow} (R_{\downarrow}) in the first magnetic layer to the left. In the second magnetic layer the resistance for the spin up (spin down) electron will be R_{\downarrow} (R_{\uparrow}), since the magnetization environment has here become totally opposite compared to the first magnetic layer.

In the case of no external magnetic field, ($H=0$), the configuration between the two magnetic layers is antiparallel (top part of figure 7). In this case the first scatterings in the left part of the multilayer system are exactly the same as before for the lower part of the figure. However, when a spin up electron enters into the second FM layer it finds itself in a totally upside-down situation where the conditions are now exactly the same as they were for the spin down electron in the initial FM layer. Thus the spin up particle will now experience a total resistance of $R_{\uparrow} + R_{\downarrow}$. The spin down particle will be affected in the same (but opposite) way and its resistance will be $R_{\downarrow} + R_{\uparrow}$. The total resistance will accordingly be $R_0 = (1/2)(R_{\uparrow}+R_{\downarrow})$. Thus the difference in resistance between the two cases (magnetic field or not) becomes:

$$\Delta R = R_H - R_0 = - (1/2)(R_{\uparrow} - R_{\downarrow})^2 / (R_{\uparrow} + R_{\downarrow}).$$

Thus the larger the difference between R_{\uparrow} and R_{\downarrow} the larger the negative magnetoresistance. This expression clearly shows that the magnetoresistance effect arises from the difference between the resistance behaviour of the spin up and down electrons.

4. Half-metals

Since magnetoresistance deals with electrical conductivity it is obvious that it is the behaviour of the electrons at the Fermi surface (defined by the Fermi energy) which is of primary interest. The more spin-polarized the density of states (DOS) at the Fermi energy, i.e., the more $N_{\uparrow}(E_F)$ deviates from $N_{\downarrow}(E_F)$, the more pronounced one expects the efficiency of the magnetoelectronic effects to be. In this respect a very interesting class of materials consists of what are called half-metals, a concept introduced by de Groot and co-workers (23). Such a property was then predicted theoretically for CrO_2 by Schwarz in 1986 (24). The name half-metal originates from the particular feature that the spin down band is metallic while the spin up band is an insulator. This is shown schematically in figure 8, and it is clear that there is a 100% spin polarization at the Fermi level. The theoretical prediction for CrO_2 was later confirmed by experiment (25,26).

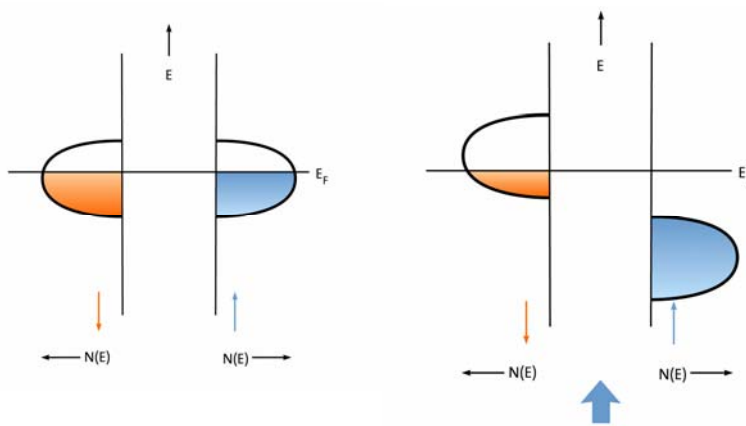

Figure 8. Schematic illustration of the density of states for non-magnetic (left) and ferromagnetic CrO_2 (right). As can be seen immediately for the ferromagnetic case (right), the spin down electrons (orange) are placed in a metallic band, while the spin up electrons (blue) show an electronic structure that is typical for an insulator. The net spin polarization is shown by a thick blue arrow.

In figure 9 we show the two DOS (spin up and spin down) for the ferromagnetic state. For a trilayer of two ferromagnetic half-metals with one non-magnetic metallic layer between them, it becomes very easy to appreciate the mechanism behind the GMR effect. When the magnetizations of the two half-metals are parallel there will be a current made up exclusively of spin down electrons. However, for an antiparallel magnetization, the spin down channel will be totally blocked for conduction of electricity. Hence a magnetic field which can switch between these two configurations will give rise to a large change in resistance, i.e. will show a strong magnetoresistance behaviour. An enhanced magnetoresistance for the half-metal CrO_2 was confirmed experimentally by Hwang and Cheong (27).

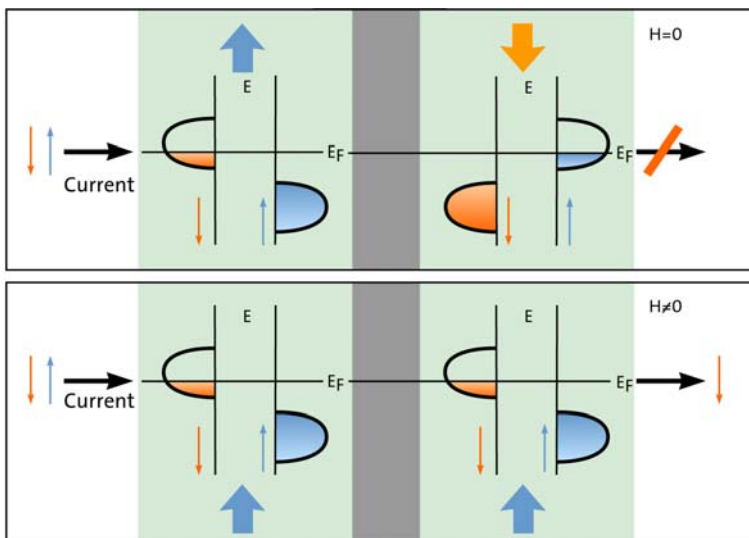

Figure 9. Illustration of the magnetoresistance effect for a half-metal. Two ferromagnetic half-metallic layers (light green) separated by a non-magnetic metal (grey). In the absence of an external magnetic field ($H = 0$) the two ferromagnets have antiparallel spin polarizations (blue and orange thick arrows at the top). In the presence of an external field ($H \neq 0$) the two magnets have parallel spin polarization (two thick blue arrows at the bottom of the figure). As can be immediately understood, there will be no current for the upper case. For the lower case there will only be a spin down current.

5. Tunneling magnetoresistance

Another variation of multilayers in the present context is to grow layered materials with an alternation between metallic and insulating layers. Here the insulating material should be only a few atomic layers thick so that there is a significant probability that electrons can quantum mechanically tunnel through the insulating barrier (figure 10). In this manner a current can be sent through the multilayer. The first publication on such a system was made by Julliere (28). This work was done for a trilayer junction with the following structure Fe/amorphous Ge/Co. The experiments were done at low temperature and an effect of about 14% was reported.

Tunneling magnetoresistance (TMR)

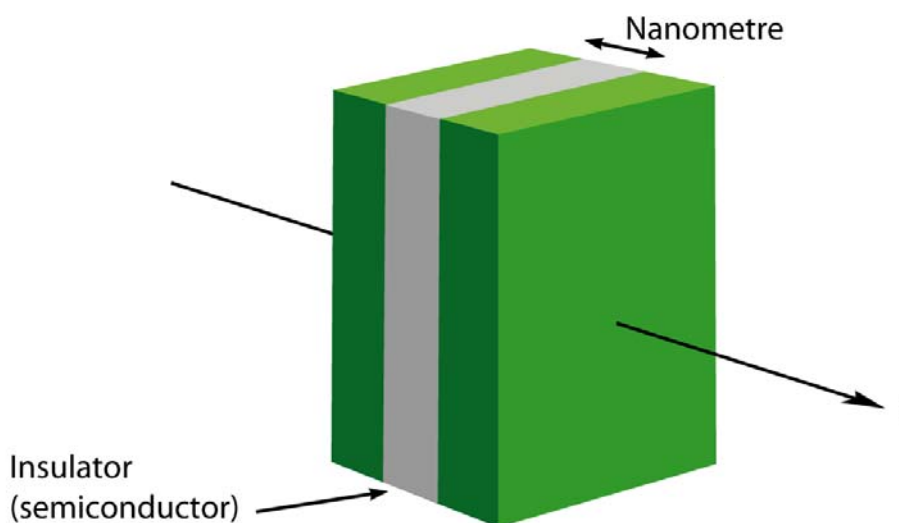

Figure 10. Illustration of tunneling magnetoresistance (TMR). Two ferromagnetic layers separated by an insulating layer (i = electron current).

The next work of this type was carried out by Maekawa and Gafvert (29). They investigated junctions of the type Ni/ NiO /FM, where FM stands for Fe, Co or Ni. The magnetoresistance they found was of the order of a few per cent, again at low temperatures. These two reports remained essentially unnoticed for a long time. In fact it was only after the discovery by Fert and Grünberg that attention focused on these types of systems again. The breakthrough came in 1995 when two groups reported significant progress. Thus Moodera and his group (30,31) measured tunneling layers on CoFe / Al₂O₃ /Co (or NiFe) and found resistance changes of 24% at 4.2 K and 12% at room temperature. Similarly, Miyazaki and Tesuka (32) used a Fe /Al₂O₃/ Fe junction and found resistance changes of 30% and 18% at 4.2 K and room temperature, respectively. Today it is rather common to find changes of the order of 50% at room temperature. This is indeed higher than the resistance changes found in “standard” GMR materials. Recently barriers of Fe/MgO/Fe have been shown to give rise to TMR-values that sometimes exceeded 200% (33,34,35).

Due to the better performance of the magnetic tunnel junctions they are expected to become the material of choice when it comes to technical applications. Their use in connection with non-volatile magnetic random access memories (MRAM) is of particular interest and MRAM systems based on TMR are already on the market. One expects that TMR based technologies will become dominant over the GMR sensors. However, the discovery of the GMR effect paved the way for the TMR technology.

6. Colossal magnetoresistance

The discovery of the GMR effect for magnetic multilayers gave rise to an increased interest in finding related effects among bulk materials (36). Thus von Helldobler and his group (37) found even larger magnetoresistance effects than for GMR in certain manganese perovskites. These materials are sometimes referred to as mixed valence systems. Jin and co-workers (38) also found these effects, where the resistance change in an applied magnetic field could be several magnitudes higher than for GMR. Hence the observed effect became known as colossal magnetoresistance (CMR). These extraordinary systems exhibit a very rich variety of exceptional properties, where electron correlations play a very central role. However it is unlikely that they will become of technological interest, mainly because the required magnetic fields are very high.

7. More recent developments

Here we will just mention a few of the vast number of different research areas which represent more recent trends regarding spin materials and their applications. One such area is for example magnetic semiconductors, where the Ohno's group demonstrated the potential of such materials (39,40) using the semiconductor (Ga, Mn)As.

Another area concerns spin injection. Here the early work by Johnson on metallic systems should be mentioned (41,42). Injection of spin from a metallic ferromagnet into a semiconductor was successfully accomplished by Zhu et al. (43) and Hanbicki et al. (44), using Fe and GaAs.

Injection of spins from a magnetic semiconductor to a non-magnetic semiconductor was shown by Ohno et al. (45) and by Fiederling et al. (46). The question of how far spin-polarized electrons can travel in a material while maintaining their spin polarization is of great importance and promising work has been reported by Awschalom and his colleagues (47,48,49).

Very intense work is now being directed towards magnetic switching induced by spin-currents. This interest started from two theoretical papers where it was shown that a spin-current through a magnetic multilayer can lead to a magnetization reversal (50,51). This prediction was soon verified experimentally (52,53,54). The realization of current induced domain wall motions (55,56,57) forms the basis for the idea of a magnetic "Race-Track Memory" (58).

8. Concluding remarks

The discovery by Albert Fert and Peter Grünberg of giant magnetoresistance (GMR) was very rapidly recognized by the scientific community. Research in magnetism became fashionable with a rich variety of new scientific and technological possibilities. GMR is a good example of how an unexpected fundamental scientific discovery can quickly give rise to new technologies and commercial products. The discovery of GMR opened the door to a new field of science, magnetoelectronics (or spintronics), where **two** fundamental properties of the electron, namely its charge **and** its spin, are manipulated simultaneously. Emerging nanotechnology was an original prerequisite for the discovery of GMR, now magnetoelectronics is in its turn a driving force for new applications of nanotechnology. In this field, demanding and exciting scientific and technological challenges become intertwined, strongly reinforcing progress.

References

1. W. Thomson, "On the Electro-Dynamic Qualities of Metals: Effects of Magnetization on the Electric Conductivity of Nickel and of Iron", *Proceedings of the Royal Society of London*, **8**, pp. 546–550 (1856–1857).
2. I.A. Campbell and A. Fert, "Transport Properties of Ferromagnets" in *Ferromagnetic Materials*, ed. E.P. Wohlfarth, North-Holland, Amsterdam, Vol. 3, p. 747 (1982).
3. G. Binasch, P. Grünberg, F. Saurenbach, and W. Zinn, "Enhanced magnetoresistance in layered magnetic structures with antiferromagnetic interlayer exchange", *Phys. Rev. B* **39**, 4828 (1989).
4. M.N. Baibich, J.M. Broto, A. Fert, F. Nguyen van Dau, F. Petroff, P. Eitenne, G. Creuzet, A. Friederich, and J. Chazelas, "Giant Magnetoresistance of (001)Fe/(001)Cr Magnetic Superlattices", *Phys. Rev. Lett.* **61**, 2472 (1988).
5. See for example: J. Kübler, "*Theory of itinerant electron magnetism*", Clarendon Press, Oxford (2000) and P. Mohn, "*Magnetism in the Solid State*", Springer-Verlag, Berlin, Heidelberg (2003).
6. C. Herring, "*Magnetism; a treatise on modern theory and materials*", Vol. **4**, series eds. G.T. Rado and H. Suhl, Academic Press, New York (1966).
7. N.F. Mott, "The Electrical Conductivity of Transition Metals", *Proc. Roy. Soc.* **A153**, 699 (1936).
8. A. Fert and I.A. Campbell, "Two-current conduction in nickel", *Phys. Rev. Lett.* **21**, 1190 (1968).
9. I. Schuller, C.M. Falco, J. Williard, J. Ketterson, B. Thaler, R. Lacos, and R. Dee, "Transport Properties of the Compositionally Modulated Alloy Cu/Ni," *AIP Conference Proceedings* **53**, 417 (1979).
10. J.P. Renard and P. Beauvillain, "Interface Effects in Ultrathin Ferromagnetic Films", *Physica Scripta T19 B*, 405 (1987).
11. E. Vélú, C. Dupas, D. Renard, J.P. Renard, and J. Seiden, "Enhanced Magnetoresistance of Ultrathin (Au/Co)_n Multilayers with Perpendicular Anisotropy", *Phys. Rev. B* **37**, 668 (1988).
12. H. Sato, P.A. Schroeder, J. Slaughter, W.P. Pratt Jr, and Abdul-Razzaq, "Galvanomagnetic Properties of Ag/M (M=Fe,Ni,Co) Layered Metallic Films", *Superlattices and Microstructures* **4**, 45 (1988).
13. C.F. Majkrzak, J.W. Cable, J. Kwo, M. Hong, D.B. McWhan, Y. Yafet, and J.V. Waszczak, and C. Vettier, "Observation of a Magnetic Antiphase Domain Structure with Long-Range Order in a Synthetic Gd-Y Superlattice", *Phys. Rev. Lett.* **56**, 2700 (1986).
14. P. Grünberg, R. Schreiber, Y. Pang, M.B. Brodsky, and H. Sowers, "Layered Magnetic Structures: Evidence for Antiferromagnetic Coupling of Fe Layers across Cr Interlayers", *Phys. Rev. Lett.* **57**, 2442 (1986).

15. J.E. Ortega, F.J. Himpsel, G.J. Mankey and R.F. Willis, "Quantum-Well States and Magnetic Coupling between Ferromagnets through a Noble-Metal Layer", *Phys. Rev. B* **47**, 1540 (1993).
16. M.B. Salamon, S. Sinha, J.E. Cunningham, R.E. Erwin, J. Borchers, and C.P. Flynn, "Long-range incommensurate magnetic order in a Dy-Y multilayer", *Phys. Rev. Lett.* **56**, 259 (1986).
17. A. Heinrich, Z. Celinski, J.F. Cochran, W.B. Muir, J. Rudd, Q. M. Zhong, A.S. Arrott, K. Myrtle and J. Kirschner, "Ferromagnetic and Antiferromagnetic Exchange Coupling in bcc Epitaxial Ultrathin Fe(001)/Cu(001)/Fe(001) Trilayers", *Phys. Rev. Lett.* **64**, 673 (1990).
18. S.S.P. Parkin, N. More and K.P. Roche, "Oscillations in Exchange Coupling and Magnetoresistance in Metallic Superlattice Structures – Co/Ru, Co/Cr and Fe/Cr", *Phys. Rev. Lett.* **64**, 2304 (1990).
19. S.S.P. Parkin, "Systematic Variation of the Strength and Oscillation Period of Indirect Magnetic Exchange Coupling through the 3d, 4d, and 5d Transition Metals", *Phys. Rev. Lett.* **67**, 3598 (1991).
20. B. Dieny, V.S. Speriosu, S.S.P. Parkin and B.A. Gurney, "Giant Magnetoresistance in Soft Ferromagnetic Multilayers", *Phys. Rev. B* **43**, 1297 (1991).
21. A. Chaiken, C.J. Gutierrez, J.J. Krebs and G.A. Prinz, "Composition Dependence of Giant Magnetoresistance in Fe/Ag/CoxFe1-x Sandwiches", *J. Magn. Magn. Mat.* **125**, 228 (1993).
22. D.E. Heim, R.E. Fontana, C. Tsang and V.S. Speriosu, "Design and Operation of Spin-Valve Sensors", *IEEE Trans. on Magn.* **30**, 316 (1994).
23. R.A. de Groot, F.M. Mueller, P.G. van Engen, and K.H.J. Buschow, "New Class of Materials: Half-Metallic Ferromagnets", *Phys. Rev. Lett.* **50**, 2024 (1983).
24. K. Schwarz, "CrO₂ predicted as a half-metallic ferromagnet", *J. Phys. F*, **16**, L211 (1986).
25. K.P. Kämper, W. Schmitt, G. Güntherodt, R.J. Gambino and R. Ruf, "CrO₂ – A New Half-Metallic Ferromagnet?", *Phys. Rev. Lett.* **59**, 2788 (1987).
26. Y. Ji, G.J. Strijkers, F.Y. Yang, C.L. Chien, J.M. Byers, A. Anguelouch, Gang Xiao and A. Gupta, "Determination of the Spin Polarization of Half-Metallic CrO₂ by Point Contact Andreev Reflection", *Phys. Rev. Lett.* **86**, 005585 (2001).
27. Y. Hwang and S.-W. Cheong, "Enhanced Intergrain Tunneling Magnetoresistance in Half-Metallic CrO₂ Films", *Science* **278**, 1607 (1997).
28. M. Julliere, "Tunneling between Ferromagnetic Films", *Phys. Lett. A* **54**, 225 (1975).
29. S. Maekawa and U. Gähvert, "Electron Tunneling between Ferromagnetic Films", *IEEE Trans. Magn. MAG* **18**, 707 (1982).
30. J.S. Moodera, L.R. Kinder, T.M. Wong and R. Meservey, "Large Magnetoresistance at Room Temperature in Ferromagnetic Thin Film Tunnel Junctions", *Phys. Rev. Lett.* **74**, 3273 (1995).

31. J. Moodera and G. Mathon, "Spin polarized tunneling in ferromagnetic junctions", *J. Magn. Mater.*, **200**, 248 (1999).
32. T. Miyazaki and N. Tezuka, "Giant Magnetic Tunneling Effect in Fe/Al₂O₃/Fe Junction", *J. Magn. Mater.* **139**, L231 (1995).
33. S. Yuasa, A. Fukushima, T. Nagahama, K. Ando and Y. Suzuki, "High Tunnel Magnetoresistance at Room Temperature in Fully Epitaxial Fe/MgO/Fe Tunnel Junctions due to Coherent Spin-Polarized Tunneling", *Jpn. J. Appl. Phys.* **43**, L588 (2004).
34. S. Yuasa, T. Nagahama, A. Fukushima, Y. Suzuki, and K. Ando, "Giant room-temperature magnetoresistance in single crystal Fe/MgO/Fe magnetic tunnel junctions", *Nature Materials* **3**, 868 (2004).
35. S.S.P. Parkin, C. Kaiser, A. Panchula, P.M. Rice, B. Hughes, M. Samant, and S.-H. Yang, "Giant tunneling magnetoresistance at room temperature with MgO(100) tunnel barriers", *Nature Materials* **3**, 862 (2004).
36. R.M. Kusters, J. Singleton, D.A. Keen, R. McGreevy and W. Hayes, "Magnetoresistance measurements on the magnetic semiconductor Nd_{0.5}Pb_{0.5}MnO₃", *Physica* **155B**, 362 (1989).
37. R. von Helmolt, J. Wecker, B. Holzapfel, L. Shultz, and K. Samwer, "Giant negative magnetoresistance in perovskitelike La_{2/3}Ba_{1/3}MnO_x ferromagnetic films", *Phys. Rev. Lett.* **71**, 2331 (1993).
38. S. Jin, T.H. Tiefel, M. McCormack, R.A. Fastnacht, R. Ramesh, and L.H. Chen, "Thousandfold Change in Resistivity in Magnetoresistive La-Ca-Mn-O Films", *Science* **264**, 413 (1994).
39. H. Ohno, "Making Nonmagnetic Semiconductors Ferromagnetic", *Science* **281**, 951 (1998).
40. H. Ohno, D. Chiba, F. Matsukura, T. Omiya, E. Abe, T. Diet, Y. Ohno, and K. Ohtani, "Electric-field control of ferromagnetism", *Nature* **408**, 944 (2000).
41. M. Johnson and R.H. Silsbee, "Interfacial charge-spin coupling: Injection and detection of spin magnetization in metals", *Phys. Rev. Lett.* **55**, 1790 (1985).
42. M. Johnson, "Bipolar Spin Switch", *Science* **260**, 320 (1993).
43. H.J. Zhu, M. Ramsteiner, H. Kostial, M. Wassermaier, H.-P. Schönherr, and K.H. Ploog, "Room-Temperature Spin Injection from Fe into GaAs", *Phys. Rev. Lett.* **87**, 016601 (2001).
44. A.T. Hanbicki, B.T. Jonker, G. Itskos, G. Kioseoglou and A. Petrou, "Efficient electrical spin injection from a magnetic metal/tunnel barrier contact into a semiconductor", *Appl. Phys. Lett.* **80**, 1240 (2002).
45. Y. Ohno, D.K. Young, B. Beschoten, F. Matsukura, H. Ohno and D.D. Awschalom, "Electrical spin injection in a ferromagnetic semiconductor heterostructure", *Nature* **402**, 790 (1999).

46. R. Fiederling, M. Keim, G. Reuscher, W. Ossau, G. Schmidt, A. Waag and L.W. Molenkamp, "Injection and detection of a spin-polarized current in a light-emitting diode," *Nature* **402**, 787 (1999).
47. J.M. Kikkawa, L.P. Smorchkova, N. Samarth and Awschalom, "Room-Temperature Spin Memory in Two-Dimensional Electron Gases", *Science* **277**, 1284 (1997).
48. I. Malajovich, J.J. Berry, N. Samarth and D.D. Awschalom, "Persistent sourcing of coherent spins for multifunctional semiconductor spintronics", *Nature* **411**, 770 (2001).
49. J.A. Gupta, R. Knobel, N. Samarth and D.D. Awschalom, "Ultrafast Manipulation of Electron Spin Coherence", *Science* **292**, 2458 (2001).
50. J.C. Slonczewski, "Current-driven excitation of magnetic multilayers", *J. Magn. Magn. Mater.* **159**, L1 (1996).
51. L. Berger, "Emission of spin waves by a magnetic multilayer traversed by a current", *Phys. Rev.* **54**, 9353 (1996).
52. E. B. Myers, D.C. Ralph, J.A. Katine, R.N. Louie and R.A. Buhrman, "Current-Induced Switching of Domains in Magnetic Multilayer Devices", *Science* **285**, 867 (1999).
53. J.A. Katine, F.J. Albert, and R.A. Buhrman, "Current-Driven Magnetization Reversal and Spin-Wave Excitations in Co/Cu/Co Pillars", *Phys. Rev. Lett.* **84**, 3149 (2000).
54. F. J. Albert, J.A. Katine and R.A. Buhrman, "Spin-Polarized current switching of a Co thin film nanomagnet", *Appl. Phys. Lett.* **77**, 3809 (2000).
55. J. Grollier, P. Boulenc, V. Cros, A. Hamzić, A. Vaurès, A. Fert and G. Faini, "Switching a Spin Valve Back and Forth by Current-induced Domain Wall Motion", *Appl. Phys. Lett.* **83**, 509 (2003).
56. M. Tsoi, R.E. Fontana and S.S.P. Parkin, "Magnetic Domain Wall Motion Triggered by an Electric Current", *Appl. Phys. Lett.* **83**, 2617 (2003).
57. M. Kläui, P.-O. Jubert, R. Allenspach, A. Bischof, J.A.C. Bland, G. Faini, U. Rüdiger, C.A.F. Vaz, L. Vila and C. Vouille, "Direct Observation of Domain-Wall Configurations Transformed by Spin Currents", *Phys. Rev. Lett.* **95**, 026601 (2005).
58. For further references see L. Thomas, M. Hayashi, X. Jiang, R. Moriya, C. Rettner and S. Parkin, "Resonant Amplification of Magnetic Domain-Wall Motion by a Train of Current Pulses", *Science* **315**, 5818 (2007), and S.S.P. Parkin, U.S. Patent 6,834,005 (2004).